

PH10 (Phantom 10) Series

Electric Heated

Model Lengths: 36"–144"

Environmental Separation (up to 12')

Insect Control (up to 10')



atmosphere is everything

14716 S. BROADWAY, GARDENA, CA 90248 • Ph: (310)532-1555 • Fax: (310)-532-3030 • www.marsair.com

© Copyright Mars Air Systems, LLC 2014

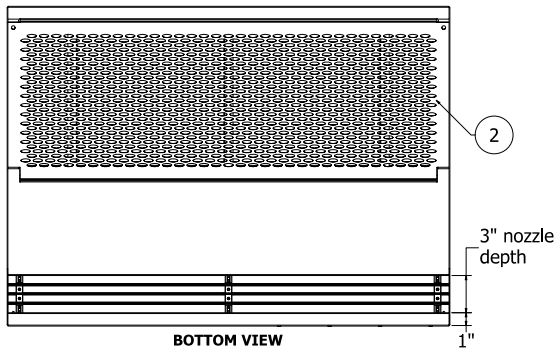
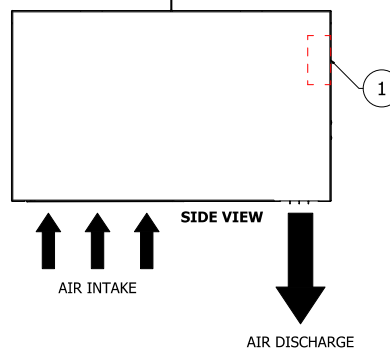
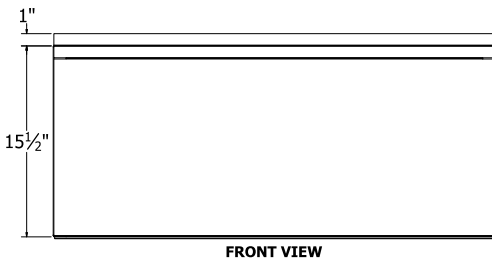
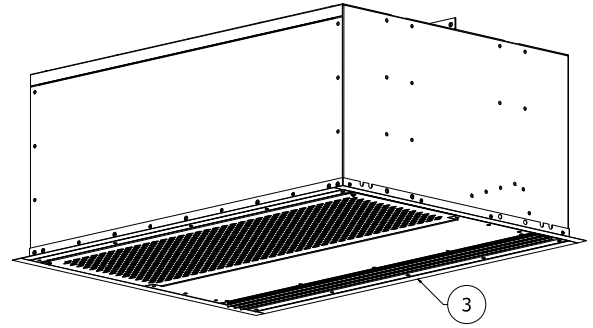
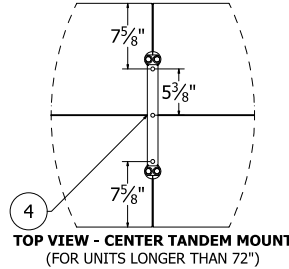
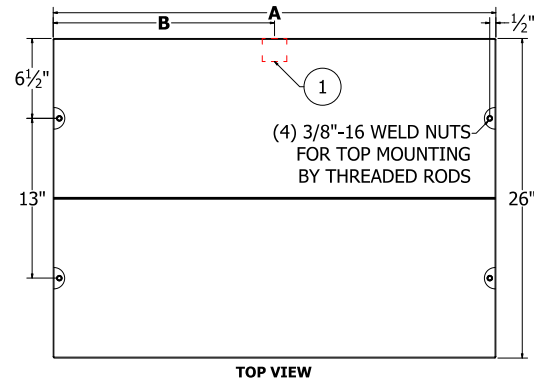

Notes:

1. Internal junction box (j-box) provided for electrical wiring.
2. Cleanable polyester filters are installed standard. Optional washable aluminum or pleated paper filters are also available.
3. (4) 1" wide matching trim pieces are included and shipped loose for optional installation.
4. Units up to 72" in width can be suspended from both ends without intermediate support. Longer units are double units and must be supported in the center.
5. Recommended service clearances are 2" to the left and right sides and 18" on top of the unit.
6. Circuit protection (per NEC) to be installed by others.
7. To prevent accidental damage during operation, unit must be installed so that the bottom of the air curtain does not extend below the door header.



Model Number	Overall Length A (in)	Nozzle Length (in)	Mechanical Data			AMCA Certified Lab Data				
			J-box Distance from Each Edge B (in)	Motor (hp)	Weight (lb)	Max Core Velocity at Nozzle (in)	Avg Velocity (fpm)	Volume (cfm)	Uniformity (%)	Power Rating (watt)
<input type="checkbox"/> PH1036-1E**-PW	36	36	18	½	65	3500	1623	1217	86	455
<input type="checkbox"/> PH1042-1E**-PW	42	42	21	½	70	4500	1642	1437	82	462
<input type="checkbox"/> PH1048-1E**-PW	48	48	24	½	75	3400	1383	1383	93	467
<input type="checkbox"/> PH1072-2E**-PW	72	72	36	(2) ½	120	3500	1623	2434	86	910
<input type="checkbox"/> PH1084-2E**-PW	84	84	(2) 21	(2) ½	140	4500	1642	2874	82	924
<input type="checkbox"/> PH1096-2E**-PW	96	96	(2) 24	(2) ½	145	3400	1383	2766	93	934
<input type="checkbox"/> PH10108-3E**-PW	108	108	(2) 18	(3) ½	195	3500	1623	3651	86	1365
<input type="checkbox"/> PH10144-4E**-PW	144	144	(2) 36	(4) ½	260	3500	1623	4868	86	1820
<i>The following models are not licensed to bear the AMCA seal</i>										
<input type="checkbox"/> PH1060-2E**-PW	60	60	30	(2) ½	115	4400	1887	2359	93	899
<input type="checkbox"/> PH10120-4E**-PW	120	120	(2) 30	(4) ½	230	4400	1887	4719	93	1797

* – Use corresponding letters in "Electrical Data" column headers (see page 2) to complete the model numbers.

Note: above data is for 60 Hz at 1725 RPM. For 50 Hz, RPM is 1425 with a 17% reduction in performance.

• The AMCA Certified Ratings Seal applies to airflow rate, average outlet velocity, outlet velocity uniformity, velocity project, and power rating at free delivery only.

NOTE: Mars Air Systems, LLC reserves the right to change specifications and product design without notice. Such revisions do not entitle the buyer to corresponding changes, improvements, additions, or replacements for previously purchased equipment.

PH10 (Phantom 10) Series

Electric Heated

Model Lengths: 36"–144"

Environmental Separation (up to 12')

Insect Control (up to 10')



atmosphere is everything

14716 S. BROADWAY, GARDENA, CA 90248 • Ph: (310)532-1555 • Fax: (310)-532-3030 • www.marsair.com
© Copyright Mars Air Systems, LLC 2014

Standard Features:

Air curtain

- ❖ ETL-certified to conform to UL 2021 (US) and CSA 22.2 (Canada) standards for indoor use
- ❖ AMCA-certified to AMCA 211 (includes performance testing per AMCA 220)
 - Certified models are approved for use as alternate to vestibules (per ASHRAE 90.1, IECC, and IgCC)
- ❖ Sleek self-contained one-piece heavy-gauge corrosion-proof paint lock metal design
- ❖ Rust preventative electrostatic polyurethane powder coating
 - Standard color is Pearl White (PW)
- ❖ ½ HP continuous duty Totally Enclosed Air Over (TEAO) motors (NEMA 1)
- ❖ Adjustable air directional vanes with 40° sweep front to back
- ❖ 18-month parts warranty
- ❖ Freight included (FOB continental USA)
- ❖ Proudly made in the USA

Electric heater coil and wiring

- ❖ Coils are open type (for rapid temperature rise) and are located directly in the air curtain's intake air stream
- ❖ Manual reset thermal overload protection provided
- ❖ Control voltage is 24V
- ❖ Controls are internally mounted and prewired to receive power connection – accessible through the bottom intake or top access panels
- ❖ 24-volt thermostat with "heat/off/fan" capability is shipped loose for field installation
 - Not applicable for units with SimpleLink

Mars Recommended Accessories (see [catalog](#) for complete listing):

- ❖ [Door Limit Switches](#) (\$)
 - 99-018, Commercial surface mounted magnetic switch, 24V
 - ❖ [Controllers](#)
 - SK-EU, [SimpleLink](#), 208-575V (460-575V, 3PH needs additional 115-230V, 1PH power), Integral Control, NEMA1
 - ❖ [Factory Mounted Control Options](#)
 - INS-TD, Adjustable time delay (1 sec to 17 min)
 - INS-HD, Heat on demand
 - INS-2S, Unit mounted 2 speed switch (460-575V, 3PH needs additional 115V-230V, 1PH power)
 - BMS-300, BMS for monitor and control

Note: dry contact provided in panel for monitoring motor and heater. 24Vac signal provided from panel for controlling motor and heater
 - ❖ [Disconnects](#) (\$)
 - 99-122 & 99-123, Non-Fused Disconnect, remote mounted, 600V, 32A & 80A respectively, 3 Pole, IP65
 - 99-***-**, Fused Disconnect, remote mounted, 240V-600V, 30A-100A, 3 Pole, NEMA3R (see disconnect submittals for complete part numbers)
- (S) = Shipped loose

Sound Levels (measured at 10' in a free field):

1 Motor Unit = 66 dBA, 2 Motor Unit = 68 dBA, 3 Motor Unit = 71 dBA, 4 Motor Unit = 73 dBA

Three Phase Electrical Data Full Load Amp (FLA)	Unit Voltage (Voltage Code)			Heater Kilowatts (Wattage Code)				Temp Rise °F
	208V/3Ø <input type="checkbox"/> (E)	230V/3Ø <input type="checkbox"/> (F)	460V/3Ø <input type="checkbox"/> (H)	(H)	(N)	(S)	(T)	
<input type="checkbox"/> PH1036-1E**-PW	36.5	33.5	16.8	12	-	-	-	31
<input type="checkbox"/> PH1042-1E**-PW	36.5	33.5	16.8	12	-	-	-	26
<input type="checkbox"/> PH1048-1E**-PW	36.5	33.5	16.8	12	-	-	-	27
<input type="checkbox"/> PH1060-2E**-PW	72	66	32.6	-	24	-	-	36
<input type="checkbox"/> PH1072-2E**-PW	72	66	32.6	-	24	-	-	31
<input type="checkbox"/> PH1084-2E**-PW	72	66	32.6	-	24	-	-	26
<input type="checkbox"/> PH1096-2E**-PW	72	66	32.6	-	24	-	-	27
<input type="checkbox"/> PH10108-3E**-PW	107.5	98.5	48.4	-	-	36	-	31
<input type="checkbox"/> PH10120-4E**-PW	144	131	64.2	-	-	-	48	36
<input type="checkbox"/> PH10144-4E**-PW	144	131	64.2	-	-	-	48	31

* - Use corresponding letters in "Voltage Code" and "Wattage Code" column headers to complete the model numbers.

Ampacity (MCA) = total FLA x 1.25

Amps per motor (included in values above):

2.5A @ 208-230V/1Ø; 1.8A @ 208V/3Ø; 1.6A @ 230/3Ø; 0.8A @ 460V/3Ø

Single Phase Electrical Data Full Load Amp (FLA)	Unit Amperage (Voltage Code)		Heater Kilowatts (Wattage Code)				Temp Rise °F
	208V/1Ø <input type="checkbox"/> (B)	230V/1Ø <input type="checkbox"/> (C)	(B)	(H)	(K)	(N)	
<input type="checkbox"/> PH1036-1E**-PW	31.5	29.5	6	-	-	-	16
<input type="checkbox"/> PH1042-1E**-PW	31.5	29.5	6	-	-	-	13
<input type="checkbox"/> PH1048-1E**-PW	31.5	29.5	6	-	-	-	14
<input type="checkbox"/> PH1060-2E**-PW	63	58	-	12	-	-	18
<input type="checkbox"/> PH1072-2E**-PW	63	58	-	12	-	-	16
<input type="checkbox"/> PH1084-2E**-PW	63	58	-	12	-	-	13
<input type="checkbox"/> PH1096-2E**-PW	63	58	-	12	-	-	14
<input type="checkbox"/> PH10108-3E**-PW	94.5	86.5	-	-	18	-	16
<input type="checkbox"/> PH10120-4E**-PW	126	115	-	-	-	24	18
<input type="checkbox"/> PH10144-4E**-PW	126	115	-	-	-	24	16

* - Use corresponding letters in "Voltage Code" and "Wattage Code" column headers to complete the model numbers.

Ampacity (MCA) = total FLA x 1.25

Amps per motor (included in values above): 2.5A @ 208-230V/1Ø

AMCA Certified Projection Velocity		
Model	Distance from Nozzle (in)	Average Core Velocity (fpm)
PH1036-1E*	40	961
	80	840
	120	772
	160	714

EXAMPLE

PH10 72 - 2 E H N - PW

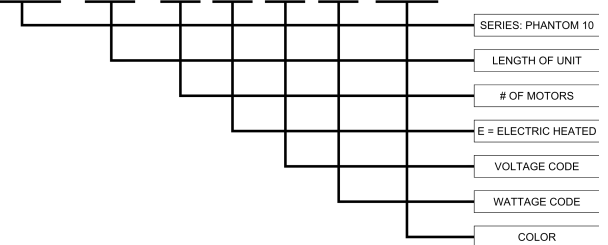

MARS Air Systems, LLC certifies that the Air Curtains shown on this data sheet are licensed to bear the AMCA seal. The ratings shown are based on tests and procedures performed in accordance with AMCA Publication 211 and comply with the requirements of the AMCA Certified Ratings Program.

The AMCA Certified Ratings Seal applies to airflow rate, average outlet velocity, outlet velocity uniformity, velocity projection and power rating at free delivery only.

NOTE: Models PH1060-2 and PH10120-4 are not AMCA-certified.