

Door Limit Switches



NEMA1 to NEMA9 Models

atmosphere is everything

14716 S. BROADWAY, GARDENA, CA 90248 • Ph: (310)532-1555 Fax: (310)-532-3030 • www.marsair.com
© Copyright Mars Air Systems, LLC 2014

Door Limit Switches

Door Switch Number	Description	Voltage	Phase	HP	Amperage	Poles	NEMA Rating
99-013	Standard Roller Type	250V	1	1	20	1	NEMA 1
99-014	Standard Combination Plunger/Roller Type	250V	1	1	20	1	NEMA 1
99-270	Washdown Roller Type	250V	1	1	20	1	NEMA 4X
99-016	Explosion Resistant 1 Roller Type	250V	1	3/4	15	1	NEMA 7 & 9

Note: DO NOT GROUND the COM terminal. This is the common terminal and not ground or neutral. Please see the wiring instructions for the switches.

Features:

- ❖ UR (UL Recognized) and rated for NEMA 1 (field installed by others)
- ❖ Combination plunger/roller (99-014) & Roller Type (99-013) door limit switches available to suit various applications
- ❖ Only available for 115V, 208V or 230V, 1Ø power (If any of the ratings are exceeded, an optional motor control panel must be used)
- ❖ Maximum ratings of 1 HP, 250V and 20A. See model specs
- ❖ Single pole terminal (1P) normally closed (NC) and normally opened (NO) contact. Only the NC terminals are used and provided with terminal screws
- ❖ Used when automatic control of an air curtain(s) is required
- ❖ Turns the air curtain on when the door opens and off when the door closes
- ❖ 1 year parts warranty
- ❖ Requires less than 1/8" of travel or 2 lbs. of force on the switch plunger to energize and de-energize the air curtain
- ❖ 1/2" FPT conduit connection (field wired by others)
- ❖ (2) 11/64" mounting holes provided*
*Do not use a fastener larger than a #6 sheet metal screw or a #8 Machine screw to mount this door limit switch. Forcing larger screws through the mounting holes may destroy the switch and void the warranty.

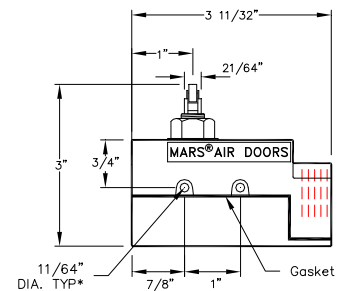
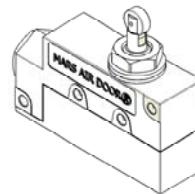

99-014 – Combination Plunger/Roller Type

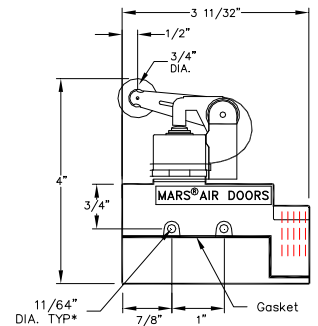
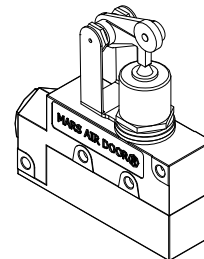

99-013 - Roller Type

Options and Accessories: (see Accessories Brochure)

Washdown

- ❖ UR (UL Recognized) and rated for NEMA4X/IP55 (field installed by others)
- ❖ Roller Type 99-270 are rated for 250V, 20A, 1 HP

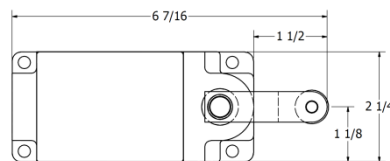
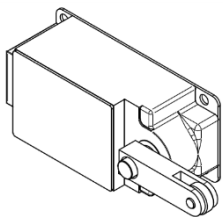

99-270 – Washdown Roller Type

Explosion Resistant

- ❖ UR (UL Recognized) and rated for NEMA 7 & 9 (Class 1, Division 1, Group D) (field installed by others)
- ❖ Roller Types 99-016 are rated for 250V, 15A, ¾ HP

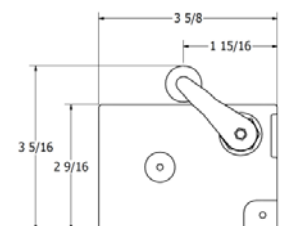
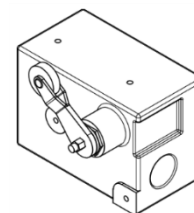

99-016 – Explosion Resistant Roller Type

NOTE: MARS AIR SYSTEMS, LLC reserves the right to change specifications and product design without notice. Such revisions do not entitle the buyer to corresponding changes, improvements, additions, or replacements for previously purchased equipment.